



TERMOMETRO - TERMOSTATO SONDA INCORPORADA - Salida posterior



CODIGO BASE	BTTP 01	BTTP 15	BTTP 20	BTTP 25	BTTP 30	BTTP 35
Escala termostato °C	-30/+35	0/+40	0/+90	0/+120	+60/+210	+50/+300
Escala termómetro °C	-40/+40	-40/+40	0/+90	0/+120	+50/+350	+50/+350
Diferencial fijo °K	1,5 ±1	2 ±1	4 ±1	4 ±1	5 ±2	10 ±2
Temp. Max. Cabeza °C	80	80	80	80	150	150
Temp. Max. Bulbo °C	65	120	150	150	260	330
Long. Zona Activa mm.	215	95	95	95	55	195
Long. Min. Funda mm.	225	120	120	120	120	225
Ø Funda mm.	Latón	15	15	15	15	10
	Inox.	16	16	16	16	10
	Teflon	CONSULTAR				
Rosca conexión funda	1/2" GAS					
Conmutador	Unipolar (SPDT)					
Capacidad de ruptura	15(2,5)A 250 Vac / 10A 380 Vac					
Conexión cables	Faston 6,3 x 0,8 (DIN 46244)					
Homologaciones impulsor	 ANCC  DIN  SP					
Estanqueidad	IP65 (DIN 40050)					
Entrada cables	Pg 16					



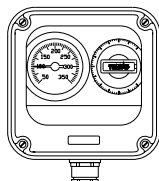
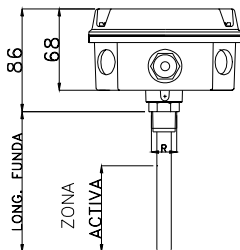
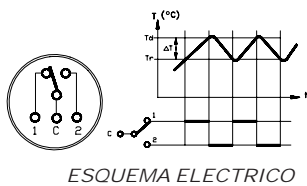

CROQUIS DE DIMENSIONES

CARACTERISTICAS DE SERIE	
Tapa ventana	
Rosca conexión funda 1/2" GAS	
Funda latón longitudes estándar (120, 150, 225, 300mm.)	
ACCESORIOS OPCIONALES	
CODIGO	DESCRIPCION
03	Funda en acero inoxidable
04	Rosca conexión M22x1,5
05	Rosca conexión 1" GAS
06	Otras roscas conexión
07	Otras longitudes de funda no estándar (especificar)
09	Certificado de calibración estándar
15	Funda recubierta con teflón
16	Funda perforada para aire
20	Especiales

TERMOMETRO - TERMOSTATO SONDA INCORPORADA - Salida lateral



CODIGO BASE	BTTL 01	BTTL 15	BTTL 20	BTTL 25	BTTL 30	BTTL 35
Escala termostato °C	-30/+35	0/+40	0/+90	0/+120	+60/+210	+50/+300
Escala termómetro °C	-40/+40	-40/+40	0/+90	0/+120	+50/+350	+50/+350
Diferencial fijo °K	1,5 ±1	2 ±1	4 ±1	4 ±1	5 ±2	10 ±2
Temp. Max. Cabeza °C	80	80	80	80	150	150
Temp. Max. Bulbo °C	65	120	150	150	260	330
Long. Zona Activa mm.	215	95	95	95	55	195
Long. Min. Funda mm.	225	120	120	120	120	225
Ø Funda mm.	Latón	15	15	15	15	10
	Inox.	16	16	16	16	10
	Teflon	CONSULTAR				
Rosca conexión funda	1/2" GAS					
Conmutador	Unipolar (SPDT)					
Capacidad de ruptura	15(2,5)A 250 Vac / 10A 380 Vac					
Conexión cables	Faston 6,3 x 0,8 (DIN 46244)					
Homologaciones impulsor	 ANCC  DIN  NPD					
Estanqueidad	IP65 (DIN 40050)					
Entrada cables	Pg 16					

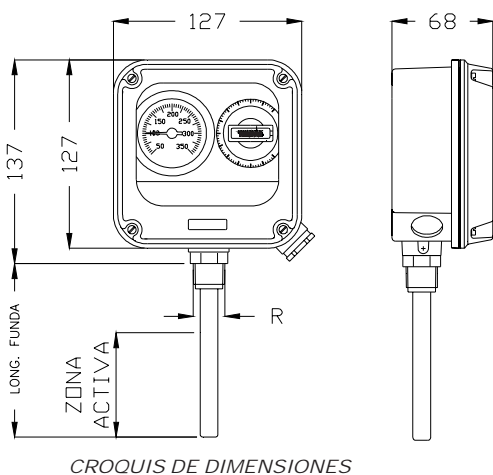
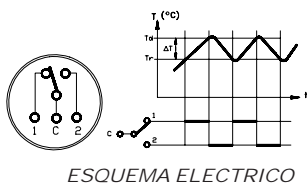

CARACTERISTICAS DE SERIE	
Tapa ventana	
Rosca conexión funda 1/2" GAS	
Funda latón longitudes estándar (120, 150, 225, 300mm.)	
ACCESORIOS OPCIONALES	
CODIGO	DESCRIPCION
03	Funda en acero inoxidable
04	Rosca conexión M22x1,5
05	Rosca conexión 1" GAS
06	Otras roscas conexión
07	Otras longitudes de funda no estándar (especificar)
09	Certificado de calibración estándar
15	Funda recubierta con teflón
16	Funda perforada para aire
20	Especiales